



**BALTIMORE
AIRCOIL COMPANY**



FXVS Closed Circuit Cooling Towers

OPERATING AND MAINTENANCE INSTRUCTIONS





Recommended maintenance and monitoring programme

Baltimore Aircoil Company equipment needs to be properly installed, operated and maintained. Documentation of the equipment used, including a drawing, technical data sheet and this manual should be kept on record. To achieve long, trouble-free and safe operation, it is necessary to establish an operating plan including a programme of regular inspection, monitoring and maintenance. All inspections, maintenance and monitoring actions should be recorded in a cooling system logbook. The operating and maintenance instructions published here can be used as a guide to achieve these goals.

In addition to establishing the operating plan and the cooling system logbook it is recommended to conduct a cooling system risk analysis, preferably by an independent third party.

For the cooling system, scale, corrosion and biological control must be established and initiated when the system is first filled with water and administered on a regular basis thereafter in accordance with recognized Codes of Practice, (such as EUROVENT 9 - 5/6, ACOP HSC L8, Guide des bonnes pratiques, Legionella et tours aéroréfrigérantes, etc.). Water sampling, test results and corrective actions should be recorded in the cooling system logbook.

For more specific recommendations on keeping your cooling system efficient and safe, contact your local BAC service provider or representative. Name, e-mail and phone number can be found on the website www.BACService.eu.

Checks and adjustments	Start-Up	Weekly	Monthly	Quarterly	Every 6 months	Annually	Shutdown
Cold water basin and basin strainers	X			X			
Operating level and make-up	X		X				
Blow down	X		X				
Sump heater package	X				X		
Belt tension	X		X				
Drive alignment	X					X	
Drive system	X				X		
Locking collar	X						
Rotation of fan(s) and pump (s)	X						
Motor voltage and current	X			X			
Unusual noise and/or vibration	X		X				

Inspections and monitoring	Start-Up	Weekly	Monthly	Quarterly	Every 6 months	Annually	Shutdown
General condition	X		X				
Heat transfer section and drift eliminators	X				X		
Combined inlet shields	X			X			
Water distribution	X				X		
Fan shaft & Axial fan	X			X			

Inspections and monitoring	Start-Up	Weekly	Monthly	Quarterly	Every 6 months	Annually	Shutdown
Fan motor	X			X			
Spray water pump	X			X			
Electric water level control package (option)	X				X		
Level or alarm switches				x			
TAB test (dip slides)	X	X					
Circulating water quality	X		X				
System overview	X					X	
Record keeping	as per event						

Lubrication	Start-Up	Weekly	Monthly	Quarterly	Every 6 months	Annually	Shutdown
Fan shaft bearings	X			X			X
Motor bearings*	X				X		
Adjustable motor base	X				X		X
Hinges & access doors bolts						X	

* only for motors with grease fittings with typical frame size > 200L (>30 kW)

Cleaning procedures	Start-Up	Weekly	Monthly	Quarterly	Every 6 months	Annually	Shutdown
Mechanical cleaning	X					X	X
Disinfection**	(X)					(X)	(X)
Drain basin and pump							X

** depends on applied code of practice

Notes

1. Water treatment and auxiliary equipment integrated in the cooling system may require additions to the table above. Contact suppliers for recommended actions and their required frequency.
2. Recommended service intervals are for typical installations. Different environmental conditions may dictate more frequent servicing.
3. When operating in ambient temperatures below freezing, the unit should be inspected more frequently (see Cold weather operations in the appropriate Operating and Maintenance Instructions).
4. For units with belt drive, tension on new belts must be readjusted after the first 24 hours of operation and monthly thereafter.

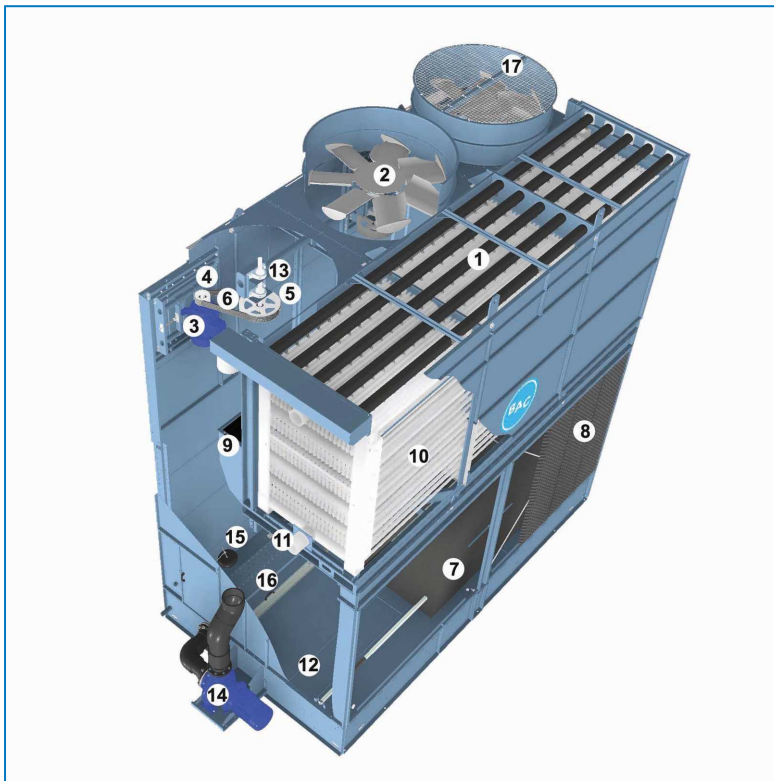

Table of contents

OPERATING AND MAINTENANCE INSTRUCTIONS

2	Construction Details	5
3	General Information	6
	Operating Conditions	6
	Connecting pipework	7
	Safety precautions	8
	Disposal requirements	9
	Non-walking surfaces	9
	Modifications by others	9
	Warranty	10
4	Water Care	11
	About water care	11
	Biological control	14
	Chemical treatment	14
	Passivation	14
5	Cold Weather Operations	16
	About cold weather operation	16
	Protection against sump water freezing	16
	Capacity control	16
	Protection against coil freezing	18
6	Maintenance Procedures	21
	Checks and adjustments	21
	Inspections and corrective actions	28
	Lubrication	34
	Cleaning procedures	36
7	Comprehensive Maintenance	38
	About comprehensive maintenance	38
	Prolonged outdoor stay	38
8	Further Assistance & Information	40
	The service expert for BAC equipment	40
	More information	40

FXVS CONSTRUCTION DETAILS



1. Spray water distribution system
2. Propeller fan
3. Fan motor
4. Motor sheave
5. Fan sheave
6. Drive system
7. Wet deck surface with integral drift eliminators
8. Combined inlet shields
9. Removable drift eliminators
10. Coil
11. Coil connections
12. Cold water basin
13. Fan shaft
14. Spray pump
15. Float ball and arm assembly
16. Strainer assembly
17. Fan guard

Operating Conditions

BAC cooling equipment is designed for the operating conditions specified below, which must not be exceeded during operation.

- **Wind Load:** For safe operation of unshielded equipment exposed to wind speeds above 120 km/h installed at a height above 30 m from the ground, contact your local BAC representative.
- **Seismic Risk:** For safe operation of equipment installed in moderate and high hazard area's contact your local BAC representative.

Standard electrical motors are suitable for an ambient temperature range from -25°C to +40°C.

With proper maintenance, the estimated life expectancy for the coils is 15 years.

- Design pressure dual coil: 10 bar
- Design pressure other coils: 7 bar

The coil type can be recognized in the nomenclature as follows:

- Dual coil: FXVS_XXXX-xxD-x
- Tri coil: FXVS_XXXX-xxT-x
- Quad coil: FXVS_XXXX-xxQ-x
- Hex coil: FXVS_XXXX-xxH-x
- Fluid inlet temperature: max. 82°C
- Fluid outlet temperature: min. 10°C

Fluids circulated through the inside of the coils must be compatible with the coil construction material, ie.

- black steel, for hot dip galvanized coils
- stainless steel AISI 304L or 316L (options)
- galvanized steel for cleanable coil (option)

Maximum spray pressure: 14 kPa (If pump(s) are installed by others, it is recommended to install a pressure gauge at the inlet of the water distribution system.)



Stand-by pump arrangements for evaporative fluid coolers require alternating operation of each pump at least twice per week to avoid stagnant water conditions and bacteriological growth.

PURGE REQUIREMENTS

The installer of BAC closed circuit cooling towers must ensure a proper air purging of the system prior to operation.

Entrained air can restrict the capacity of the cooler, resulting in higher process temperatures.

All connections (installed by others) must be leak free and tested accordingly.

CIRCULATING WATER QUALITY

The standard heat exchanger coils are made of black steel and are galvanized on the outside only. They are intended for application on closed, pressurized systems which are not open to the atmosphere in order to prevent internal corrosion of the coil and possible leaks.

The circulating water quality needs to remain within the following limits:

	Black steel galvanized
pH	7 - 10.5
Hardness (as CaCO ₃)	100 - 500 mg/l
Alkalinity (as CaCO ₃)	100 - 500 mg/l
Conductivity	< 3000 μS/cm
Chlorides	< 200 mg/l
Total suspended solids	< 10 mg/l
COD	< 50 ppm

Above values are general guidelines for pressurized closed systems closed systems with a leak rate lower than 15% of system volume per year. If the annual make-up of the closed system is greater than 15% yearly or if highly corrosive water such as water with very low hardness or alkalinity is used, it is recommended to consider alternative stainless steel material or implement a proper water treatment program to prevent steel corrosion.

Stainless steel coil are available to cool corrosive fluids or water and ethylene/propylene glycol solutions in systems open to the atmosphere. In case of stainless steel heat exchanger coils the circulating water quality needs to remain within the following limits:

	SST304L	SST316L
pH	6.5 - 10.5	6.5 - 10.5
Hardness (as CaCO ₃)	0 - 500 mg/l	0 - 500 mg/l
Alkalinity (as CaCO ₃)	0 - 500 mg/l	0 - 500 mg/l
Conductivity	< 3300 μS/cm	< 4000 μS/cm
Chlorides	< 250 mg/l	< 750 mg/l
Total suspended solids	< 10 mg/l	< 10 mg/l
COD	< 50 ppm	< 50 ppm

In all cases, regardless of the material of construction of the coil a competent water treatment company should be consulted for the specific water treatment to be applied, suitable for all the materials of construction used in the entire system.

Connecting pipework

All piping external to BAC cooling equipment must be supported separately.

In case the equipment is installed on vibration rails or springs, the piping must contain compensators to eliminate vibrations carried through the external pipework.

Suction pipe sizing should be done according to good practice, which may for larger flows require larger pipe diameters than the outlet connection. In such cases adapter pieces need to be installed.



Safety precautions

All electrical, mechanical and rotating machinery constitutes a potential hazard, particularly for those not familiar with its design, construction and operation. Accordingly, adequate safeguards (including use of protective enclosures where necessary) should be taken with this equipment both to safeguard the public (including minors) from injury and to prevent damage to the equipment, its associated system and the premises.

If there is doubt about safe and proper rigging, installation, operation or maintenance procedures, contact the equipment manufacturer or his representative for advice.

When working on operating equipment, be aware that some parts may have an elevated temperature. Any operations on elevated level have to be executed with extra care to prevent accidents.



CAUTION

Do not cover units with PVC eliminators or fill with a plastic tarpaulin. Temperature increase due to sun radiation could deform the fill or eliminators.

AUTHORIZED PERSONNEL

The operation, maintenance and repair of this equipment should be undertaken only by personnel authorized and qualified to do so. All such personnel should be thoroughly familiar with the equipment, the associated systems and controls and the procedures set forth in this and other relevant manuals. Proper care, personal protective equipment, procedures and tools must be used in handling, lifting, installing, operating, maintaining and repairing this equipment to prevent personal injury and/or property damage. Personnel must use personal protective equipment where necessary (gloves, ear plugs, etc...)

MECHANICAL SAFETY

Mechanical safety of the equipment is in accordance with the requirements of the EU machinery directive. Depending upon site conditions it also may be necessary to install items such as bottom screens, ladders, safety cages, stairways, access platforms, handrails and toe boards for the safety and convenience of the authorized service and maintenance personnel.

At no time this equipment should be operated without all fan screens, access panels and access doors in place/closed and properly secured.

When the equipment is operated with a variable fan speed control device, steps must be taken to avoid operating at or near to the fan's «critical speed».

For more information consult your local BAC representative.

ELECTRICAL SAFETY

All electrical components associated with this equipment should be installed with a lockable disconnect switch located within sight of the equipment.

In the event of multiple components, these can be installed after a single disconnect switch but multiple switches or a combination thereof are also allowed.

No service work should be performed on or near electrical components unless adequate safety measures are taken. These include, but are not limited to the following:

- Isolate the component electrically
- Lock the isolation switch in order to prevent unintentional restart
- Measure that no electrical voltage is present any more
- If parts of the installation remain energized, make sure to properly demarcate these in order to avoid confusion

Fan motor terminals and connections may have residual voltage after unit shut-down. Wait five minutes after disconnecting the voltage at all poles before opening the fan motor terminal box.

LOCATION

All cooling equipment should be located as far away as possible from occupied areas, open windows or air intakes to buildings.

LOCAL REGULATIONS

Installation and operation of cooling equipment may be subject to local regulations, such as establishment of risk analysis. Ensure regulatory requirements are consistently met.

Disposal requirements

Dismantling of the unit and treatment of refrigerants (if applicable), oil and other parts must be done with respect to the environment whilst protecting workers from potential risks related to exposure to harmful substances.

National and regional legislation for material disposal and protection of workers should be taken into account with regard to:

- Appropriate handling of construction and maintenance materials when dismantling the unit. In particular when dealing with materials that contain harmful substances, such as asbestos or carcinogenic substances.
- Appropriate disposal of the construction and maintenance materials and components such as steel, plastics, refrigerants and waste water according to local and national requirements for waste management, recycling and disposal.

Non-walking surfaces

Access to and maintenance of any component needs to be performed in accordance with all local applicable laws and regulations. If the proper and required access means are not present, temporary structures need to be foreseen. Under no circumstance can one use parts of the unit, that are not designed as an access mean, unless measures can be taken to mitigate any risks that might occur from doing so.

Modifications by others

Whenever modifications or changes are made by others to the BAC equipment without written permission of BAC, the party who has done the modification becomes responsible for all consequences of this change and BAC declines all liability for the product.



Warranty

BAC will guarantee all products to be free from manufactured defects in materials and workmanship for a period of 24 months from the date of shipment. In the event of any such defect, BAC will repair or provide a replacement. For more details, please refer to the Limitation of Warranties applicable to and in effect at the time of the sale/purchase of these products. You can find these terms and conditions on the reverse side of your order acknowledgement form and your invoice.



FXVS WATER CARE

About water care

In all cooling equipment, operating in evaporative mode, the cooling is accomplished by evaporating a small portion of the re-circulating water as it flows through the equipment. When this water evaporates, the impurities originally present in the water remain. Unless a small amount of water is drained from the system, known as blow down, the concentration of dissolved solids will increase rapidly and lead to scale formation or corrosion or both. Also, since water is being lost from the system through evaporation and blow down, this water needs to be replenished.

The total amount of replenishment, known as make-up, is defined as:

Make-up = evaporation loss + blow down

In addition to the impurities present in the make-up water, any airborne impurities or biological matter are carried into the equipment and drawn into the re-circulating water. Over and above the necessity to blow down a small quantity of water, a water treatment programme specifically designed to address scale, corrosion and biological control should be initiated when the system is first installed and maintained on a continuous base thereafter. Moreover there must be an ongoing programme of monitoring in place to ensure the water treatment system is maintaining the water quality within the control guidelines.

Check and adjustments of blow down depends on the blow down device actual in use.

To prevent excessive build-up of impurities in the circulating water, a small amount of water must be « bled » from the system at a rate to be determined by the water treatment regime. The amount of blow down is determined by the design cycles of concentration for the system. These cycles of concentration depend on the quality of the make-up water and the design guidelines for the quality of the recirculating water given below.

Make-up water to the evaporative unit should have minimum 30 ppm hardness as CaCO_3 .

Where use of a softener is necessary to achieve this, the supply to the evaporative unit should not be totally softened, but blended with the incoming unsoftened water to achieve the minimum hardness between 30 and 70 ppm as CaCO_3 .

Maintaining a minimum hardness in the make-up water offsets the corrosive properties of totally softened water and reduces the reliance on corrosion inhibitors to protect the system.

To control corrosion and scale, the water chemistry of the circulated water has to be kept within the water quality guidelines of the specific materials of construction used, as listed in the following table(s).



	Baltibond® Hybrid Coating and SST304L
pH	6.5 to 9.2
Total hardness (as CaCO ₃)	50 to 750 mg/l
Total alkalinity (as CaCO ₃)	600 mg/l max.
Total dissolved solids	2050 mg/l max.
Conductivity	3300 µS/cm
Chlorides	300 mg/l max.
Sulfates*	350 mg/l max.*
Total suspended solids	25 mg/l max.
Chlorination (as free chlorine / halogen): continuous	1.5 mg/l max.
Chlorination (as free chlorine / halogen): batch dosing for cleaning & disinfection	5-15 mg/l max. for 6 hours max. 25 mg/l max. for 2 hours max. 50 mg/l max. for 1 hour max.

Circulated water quality guidelines for Baltibond® Hybrid Coating

***Note:** Higher concentration of sulfates is allowed, provided the sum of chlorides + sulfates parameters does not exceed 650 mg/l for Baltibond®/SST304L.

***Note:** In case of a HDG coil, passivation of the coil is required. During this period, both the pH and the hardness of the spray water will have more stringent requirements. The pH must be kept between 7 and 8.2, and the hardness must be kept between 100 and 300 ppm.

	Baltiplus protection
pH	6.5 to 9.0
Total hardness (as CaCO ₃)	50 to 600 mg/l
Total alkalinity (as CaCO ₃)	500 mg/l max.
Total dissolved solids	1500 mg/l max.
Conductivity	2400 µS/cm
Chlorides	250 mg/l max.
Sulfates*	250 mg/l max.*
Total suspended solids	25 mg/l max.
Chlorination (as free chlorine / halogen): continuous	1 mg/l max.
Chlorination (as free chlorine / halogen): batch dosing for cleaning & disinfection	5-15 mg/l max. for 6 hours max. 25 mg/l max. for 2 hours max. 50 mg/l max. for 1 hour max.

Circulated water quality guidelines for Baltiplus protection

***Note:** Higher concentration of sulfates is allowed provided the sum of chlorides + sulfates parameters does not exceed 500 mg/l for Baltiplus protection.

	SST304L SST316L with HDG coil	SST316L (with SST316L coil)
pH	6.5 to 9.2	6.5 to 9.5
Total hardness (as CaCO ₃)	50 to 750 mg/l	0 to 750 mg/l
Total alkalinity (as CaCO ₃)	600 mg/l max.	600 mg/l max.
Total dissolved solids	2050 mg/l max.	2500 mg/l max.
Conductivity	3300 µS/cm	4000 µS/cm
Chlorides	300 mg/l max.	750 mg/l max.
Sulfates*	350 mg/l max.*	750 mg/l max.*
Total suspended solids	25 mg/l max.	25 mg/l max.
Chlorination (as free chlorine/halogen): continuous	1,5 mg/l max.	2 mg/l max.
Chlorination (as free chlorine/halogen): batch dosing for cleaning & disinfection	5-15 mg/l max. for 6 hours max. 25 mg/l max. for 2 hours max. 50 mg/l max. for 1 hour max.	5-15 mg/l max. for 6 hours max. 25 mg/l max. for 2 hours max. 50 mg/l max. for 1 hour max.

Circulated water quality guidelines for Stainless Steel

***Note:** Higher concentration of sulphates is allowed provided the sum of chlorides + sulphates parameters does not exceed 650 mg/l for SST304L and 1500 mg/l for SST316L.

***Note:** In case of a HDG coil, passivation of the coil is required. During this period, both the pH and the hardness of the spray water will have more stringent requirements. The pH must be kept between 7 and 8.2, and the hardness must be kept between 100 and 300 ppm.

For Ozone water treatment application:

- Stainless steel 316L execution is required.
- Ozone levels are to be maintained to 0.2 ppm ± 0.1 ppm for at least 90% of the time, with absolute maximum peaks of 0.5 ppm

Cycles of concentration are the ratio of the dissolved solids concentration in the circulating water compared to the dissolved solids concentration in the make-up water. The blow down rate can be calculated as follows:

$$\text{Blow down} = \text{Evaporation loss} / (\text{Cycles of concentration} - 1)$$

The evaporation loss is not only function of the heat load but also depends on climatic conditions, the type of equipment used and the method of capacity control, which is applied. The evaporation loss at summer conditions is approximately 0.431 l / 1000 kJ heat rejection. This number should be used for blow down valve sizing only and not for the calculation of annual water consumption.



Biological control

The growth of algae, slimes and other micro-organisms, if uncontrolled, will reduce system efficiency and may contribute to the growth of potentially harmful micro-organisms, such as Legionella, in the recirculating water system.

Accordingly a treatment programme specifically designed to address biological control should be initiated when the system is first filled with water and administered on a regular base thereafter in accordance with any regulations (national, regional) that may exist or in accordance with accepted codes of good practice, such as EUROVENT 9-5/6, VDMA Detailsheet 24649 etc.

Also during shutdown periods it is recommended to continue the water treatment programme. Alternatively, the basin and pump should be drained.

It is strongly recommended to monitor the bacteriological contamination of the recirculating water on a regular base (for example, TAB test with dip slides on a weekly base) and record all results.

Certain products used for water treatment, particular some dispersant and bio-dispersant additives, might change the properties of the water (such as the surface tension), which can cause excessive drift loss (water passing through the eliminators). In such case we recommend to review the water treatment (product type, dosage) with your water treatment expert.

In case of doubt, a short test can be performed, after cleaning & disinfection, using fresh water without addition of the concerned chemical (within the limits of the local legislation).

Chemical treatment

1. Water treatment chemicals or non-chemical systems need to be compatible with the materials of construction used in the cooling system including the evaporative cooling equipment itself.
2. In case of chemical water treatment, chemicals should be added to the recirculating water by an automatic feed system. This will prevent localised high concentrations of chemicals, which may cause corrosion. Preferably the water treatment chemicals should be fed into the cooling system at the discharge of the recirculation pump. The chemicals should not be fed in concentrated form, nor batch fed directly into the cold water sump of the evaporative cooling equipment.
3. BAC specifically discourages acid dosing as mean of scale control (unless under certain strict circumstances for open circuit cooling towers with very large system volume and remote sump, or constructed from stainless steel).
4. A competent water treatment company should be consulted for the specific water treatment programme to be applied. Next to the supply of dosing and control equipment and chemicals, the programme should include regular monthly monitoring of the circulating and make up water quality.
5. If it is proposed to operate a treatment programme outside the BAC Water Quality Control Guidelines, the BAC factory warranty may be invalidated if the water quality is persistently outside the Control Guidelines, unless specific prior written BAC approval. (Some parameters may be exceeded under certain strict circumstances.)

It is strongly recommended to check the key parameters of the circulating water quality on a monthly base. See table: "Circulated water quality guidelines". All test results need to be recorded.

Passivation

When new systems are first commissioned, special measures should be taken to ensure that galvanized steel surfaces are properly passivated to provide maximum protection from corrosion. **Passivation** is the formation of a protective, passive, oxide layer on galvanized steel surfaces.

To ensure that galvanized steel surfaces are passivated, the pH of circulating water should be kept between 7.0 and 8.2 and calcium hardness between 100 and 300 ppm (as CaCO₃) for four to eight weeks after start-up, or until new zinc surfaces turn dull grey in colour. If white deposits form on galvanized steel surfaces after the pH is returned to normal service levels, it may be necessary to repeat the passivation process.

 Full stainless steel units and units protected by the Baltibond[®] hybrid coating do not require passivation. An exception to this are units with a galvanized steel coil bundle which do still require the proper passivation procedure as described here in this section.

In case you can't keep the pH below 8.2, a secondary approach is to conduct a chemical passivation using inorganic phosphate or film-forming passivation agents. Consult your water treatment specialist for specific recommendation.

5

FXVS COLD WEATHER OPERATIONS

About cold weather operation

BAC cooling equipment can be operated in sub freezing ambient conditions provided the proper measures are taken. Listed below are general guidelines which should be followed to minimize the possibility of freeze-up. As these guidelines may not include all aspects of the anticipated operation scheme, system designer and operator must thoroughly review the system, location of the equipment, controls and accessories to ensure reliable operation at all times.

Protection against sump water freezing

To prevent sump water from freezing, either sump heaters or a remote sump located in a heated indoor area must be installed. For a seasonal shut down during the cold weather period, it is recommended to drain the sump and pump.

Drainage of the sump and pump will also be needed if dry operation is anticipated, even if sump heaters are installed. These heaters will NOT prevent sump water from freezing during dry operation at sub-freezing ambient conditions.

Remote sump installations are best suited for a flexible switch from wet to dry operation, as the sump water is protected at all times.

For dry operation applications, ensure that make-up water line is shut off and make-up valve completely drained.

Thermostats for electrical sump heaters for this equipment are to be set to maintain a sump water temperature of 4°C.



CAUTION

Switch of heaters when the sump is drained.

Capacity control

In addition to protecting the sump water, all exposed water piping, in particular make-up water lines should be heat traced and insulated.

Spray pumps also need to be heat traced and insulated from pump suction to the overflow level, if they can be exposed to sub-freezing ambient conditions.

It is necessary to prevent the recirculating water from approaching freezing conditions when the system is operating under load. The most « critical » situation occurs, if operation at subfreezing conditions coincides with light load conditions. The key to protecting the recirculating water is capacity control by adjustment of air flow to maintain the temperature of the recirculating water minimal above freezing point. As a rule of thumb this minimum temperature is 5°C, but there are applications, where even lower temperatures can be accepted. (Contact your local BAC representative for advice.)

The desired method to match the cooling capacity to load and weather conditions is to adjust the air flow by the use of modulating controls (variable speed drives).

Alternatively, multi speed fan motors or fan cycling can be applied, but fans operating on a common heat exchange section should always be operated simultaneously.

It is not recommended to cycle the spray pump as a means of controlling the unit capacity.

Whenever two speed motors are used for capacity control, a time delay of at least 15 seconds is required when switching from high to low speed. Sudden switch over might damage the drive system or the motor.

When the equipment is operated with a variable fan speed control device, steps must be taken to avoid both operating at or near to the fan's «critical speed» and below a minimum of 15 Hz for a belt driven unit (or direct driven fans) or 20 Hz for a unit with gear box. For more information consult your local BAC representative.

 When operating with VFD drives above nominal frequency be aware of the potential risk for motor overload or mechanical damages.

 It is recommended to provide sinus filters on the VFD to prevent bearing damage on fan motors.



CAUTION

Refer to fan motor nameplate data when programming a VFD.

The purpose of a low level cut out switch for pump protection is to protect the pump from running dry in case of make-up failure or extreme water loss. The status of the alarm can be checked prior to pump start-up, but should not be considered during the first minute after start-up, since activation of the pump can cause a water level drop, that might trigger the alarm. Normal make-up will stabilize the water level after a short period of time. In case the low level alarm signals, that there is no longer enough water in the cold water sump to guarantee a proper operation, the pump should be stopped (after a time delay of 60 seconds) and only manually restarted after it has been verified that the water in the sump is at or near the overflow level.

 In case the low level pump alarm is used to stop the pump, appropriate control logic should be incorporated to prevent hunting of the pump motor. Once the spray pump is stopped, the water in suspension will drain back to the tank and raise the water-level above the alarm level, which will reset the alarm immediately. A manual reset of the alarm after solving the root cause of the low level alarm is recommended. Frequent start/stop or hunting will damage the motor.

The high level alarm is located just under the overflow level and is meant to give a warning in case occur with the make up system during operation. During shut down of the pump, the alarm may be triggered. The switch can also be used to fill up the unit after shut down period before starting the pump.



Protection against coil freezing

The best protection is the use of glycol or other anti freeze solutions in appropriate concentrations. The use of such solutions influences the thermal performance of the closed circuit cooling tower and this should be taken into account, when selecting the model(s). The table below indicates the freeze protection range for various ethylene glycol concentrations (% by volume).

% Ethylene	Freeze protection
20%	-10°C
30%	-16°C
40%	-25°C
50%	-39°C

Freeze protection of ethylene glycol solutions



Glycol systems require specific inhibitors compatible with the materials of construction they come into contact with. These inhibitors generally come pre-mixed with the glycol additive for the cooling circuit.

If the system must be operated with water, the following conditions must be met simultaneously:

1. Ensure a turbulent flow through the unit at all times.
2. Maintain a minimum heat load, so that the temperature of the water leaving the coil(s) will not fall below 10°C based on -14°C ambient temperature and 20 m/s velocity. If the process load is extremely light or shut off, it may be necessary to apply an auxiliary heat load during freezing conditions. Consult your local BAC representative for advice.

Draining of the coil(s) is not recommended as a normal method of freeze protection unless the coil(s) are constructed from stainless steel or are of the cleanable type. For standard hot dip galvanized coils draining is ONLY acceptable as an emergency method of freeze protection, since draining will lead to internal corrosion of the coil. For this purpose an automatic drain valve and air vent needs to be installed to drain the coil(s) if flow stops or the fluid temperature drops below 10°C when the ambient temperature is below freezing.

Ensure that all coils and/or coil sections (split coils/multi-circuiting) can drain individually.

Model numbers FXVS	Minimum flow (l/s)	Appr. minimum heat load (kW)	
		Standard unit (kW)	Unit with positive closure damper hood (kW)
FXVS-0806x-12x-xx	5	24	14
FXVS-0806x-16x-xx	9	29	14
FXVS-0806x-20x-xx	5	33	13
FXVS-0806x-24x-xx	9	42	18
FXVS-0806x-28x-xx	5	45	18
FXVS-0806x-30x-xx	6	47	18
FXVS-0806x-32x-xx	9	49	18
FXVS-0806x-36x-xx	6	52	18
FXVS-0809x-12x-xx	5	35	18
FXVS-0809x-16x-xx	9	42	18
FXVS-0809x-20x-xx	5	48	17
FXVS-0809x-24x-xx	9	61	24
FXVS-0809x-28x-xx	5	65	23
FXVS-0809x-30x-xx	6	69	23
FXVS-0809x-32x-xx	9	72	24
FXVS-0809x-36x-xx	6	76	23
FXVS-0812x-12x-xx	5	45	22
FXVS-0812x-16x-xx	9	55	22
FXVS-0812x-20x-xx	5	62	21
FXVS-0812x-24x-xx	9	80	30
FXVS-0812x-28x-xx	5	85	28
FXVS-0812x-30x-xx	6	90	29
FXVS-0812x-32x-xx	9	95	29
FXVS-0812x-36x-xx	6	100	28
FXVS-0818x-12x-xx	5	66	30
FXVS-0818x-16x-xx	9	81	30
FXVS-0818x-20x-xx	5	91	28
FXVS-0818x-24x-xx	9	116	40
FXVS-0818x-28x-xx	5	122	37
FXVS-0818x-30x-xx	6	130	38
FXVS-0818x-32x-xx	9	139	40
FXVS-0818x-36x-xx	13	151	40
FXVS-1012x-12x-xx	6	61	23
FXVS-1012x-16x-xx	13	75	24
FXVS-1012x-20x-xx	6	85	23
FXVS-1012x-24x-xx	13	107	32
FXVS-1012x-28x-xx	6	115	30
FXVS-1012x-30x-xx	10	123	31
FXVS-1012x-32x-xx	13	129	31
FXVS-1012x-36x-xx	20	141	32
FXVS-1018x-12x-xx	6	88	31
FXVS-1018x-16x-xx	13	110	32
FXVS-1018x-20x-xx	6	124	29
FXVS-1018x-24x-xx	13	157	42
FXVS-1018x-28x-xx	6	165	38
FXVS-1018x-30x-xx	10	179	41
FXVS-1018x-32x-xx	13	189	41
FXVS-1018x-36x-xx	20	207	43

Model numbers FXVS	Minimum flow (l/s)	Appr. minimum heat load (kW)	
		Standard unit (kW)	Unit with positive closure damper hood (kW)
FXVS-1212x-12x-xx	7	67	24
FXVS-1212x-16x-xx	14	83	25
FXVS-1212x-20x-xx	7	95	24
FXVS-1212x-24x-xx	14	119	33
FXVS-1212x-28x-xx	7	127	31
FXVS-1212x-30x-xx	11	136	32
FXVS-1212x-32x-xx	14	144	33
FXVS-1212x-36x-xx	22	157	33
FXVS-1218x-12x-xx	7	97	32
FXVS-1218x-16x-xx	14	122	33
FXVS-1218x-20x-xx	7	138	30
FXVS-1218x-24x-xx	14	174	44
FXVS-1218x-28x-xx	7	183	40
FXVS-1218x-30x-xx	11	199	42
FXVS-1218x-32x-xx	14	210	43
FXVS-1218x-36x-xx	22	231	44

Minimum requirements for water flow and heat load



The "x" represents the variable numbers or characters in the model numbers.

6

FXVS MAINTENANCE PROCEDURES

Checks and adjustments

COLD WATER BASIN AND BASIN STRAINERS

The cold water basin should be inspected regularly. Any debris which may have accumulated in the basin or on the strainers should be removed.

Quarterly, or more often if necessary, the entire cold water basin should be drained, cleaned and flushed with fresh water to remove the silt and sediment which normally collects in the basin and under the wet deck surface during operation.

If not removed periodically, this sediment can become corrosive and cause deterioration of the metallic basin fittings.

When flushing the basin, the strainers should be left in place to prevent the sediment from re-entering the unit system. After the basin has been flushed, the strainers should be removed, cleaned, and replaced before refilling the basin with fresh water.



CAUTION

Do not use acid to clean the strainers.

Remote Basin

The water level in the basin of equipment designed for remote basin operation is a function of the circulating water flow rate, water outlet connection size, quantity and location, and outlet piping size and configuration. The remote basin unit is supplied without a water make-up assembly and the basin operating level during remote basin operation is not adjustable.



Cold water basin and basin strainer

OPERATING LEVEL AND MAKE-UP

Before initial start up the straps, that prevent the float ball from moving during transport, as well as the protective bag around this ball, need to be removed.



Fixation and wrapping of float ball

As the water circulating through the unit is cooled, it collects in the cold water basin and passes through the strainers into the system.

The operating water level is controlled by the make-up valve and should be maintained at the operating water level shown in the table below.

Model number	At operating level (mm)	At overflow level (mm)
FXVS-08xxx-xxx-xx	215	340
FXVS-10xxx-xxx-xx	240	360
FXVS-12xxx-xxx-xx	240	360



The "x" represents the variable numbers or characters in the model numbers.

The operating water level in the cold water basin will vary somewhat with system thermal load (evaporation rate), the bleed rate employed and the make-up water supply pressure. Because the typical winter load is less than the summer load, the winter evaporation rate is frequently less than the summer evaporation rate. With this reduced evaporation rate in winter, the water level in the cold water basin will increase unless the float is readjusted. The operating water level should be checked monthly and float re-adjusted as necessary to maintain the recommended operating level.

A float operated water make-up assembly is furnished as standard equipment on evaporative cooling equipment. It is located inside the unit within easy reach from the access door.

The standard make-up assembly (see figure below) consists of a make-up valve connected to a float arm assembly and actuated by a large diameter plastic float. The float is mounted on an all-thread rod which is held in place by wing nuts. The operating water level in the cold water basin can be adjusted by repositioning the float and all-thread rod using the wing nuts provided.

The make-up assembly should be inspected monthly and adjusted as necessary. The valve itself should be inspected annually for leakage and the valve seat replaced if necessary. The make-up water supply pressure should be maintained between 100 and 350 kPa for proper operation of the valve.

The unit basin should be closely monitored and water level adjusted as necessary during the first 24 hours of operation.

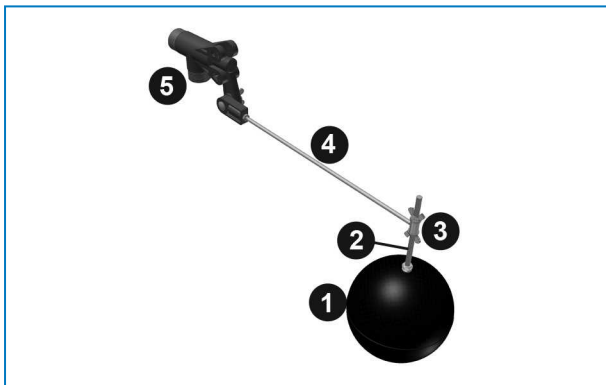

Water make-up valve assembly

1. Float ball
2. All threaded rod
3. Wing nut
4. Float arm assembly
5. Float valve



CAUTION

Supply pressure for mechanical make-up valves should be between 1 and 3,5 bar.

To check the operating level, proceed as follows:

1. Measure height from sump bottom to water level and compare with face value from table.
2. Check valve for leakage and replace valve, if necessary.

BLOW DOWN

In case of a continuous blow down with a metering valve in the bleed line, ensure that the valve is unobstructed and that blow down water can drain freely. Measure the blow down flow rate by recording the time needed to fill a given volume.

For automatic blow down using conductivity control, ensure that the conductivity probe is clean and that the blow down solenoid valve is operational. Unless you have a specific adjustment procedure, your water treatment company should check and adjust set points.

SUMP HEATER PACKAGE

Sump heaters must only operate in the winter to prevent the sump water from freezing, when the water pump(s) and the fan(s) are shut off.

Under no circumstances should sump heaters operate at other times as they could potentially heat the water to temperature levels, which are favourable to bacteriological growth. Ensure every six months the heater thermostat is properly set and clean. Also ensure that control and safety devices, such as low level cut out switches, are operational, clean and properly incorporated into the control circuit.



CAUTION

Sump heaters can be hot.

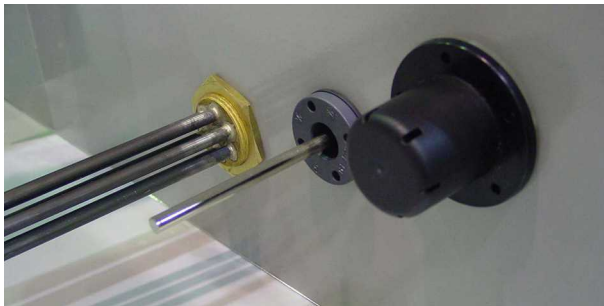

Sump heater

DRIVE SYSTEM

Belt Driven Units

The drive system consists of a specially designed belt, a fan sheave and a motor sheave. The high efficiency belt provides the premium quality necessary for evaporative cooling equipment service.

Together these components provide a highly reliable system with low maintenance requirements. The drive system should be inspected periodically to check the belt tension, condition of the sheaves and belt, and when necessary adjust the tension. The recommended service intervals are specified elsewhere.

- **Initial Start-up:** If the equipment was supplied in assembled major sections the drive has been tensioned and aligned at the factory. Also in this case it is recommended to always check drive alignment and belt tensioning. If equipment was supplied completely knocked-down (KD) then check drive alignment & belt tensioning as per procedures outlined below.
- **Seasonal Start-Up:** Readjust the tension on the belt. Check condition of sheaves.
- **Operation:** After initial unit start-up or the installation of a new belt, the tension must be readjusted after the first 24 hours of operation. Thereafter the condition of the belt should be checked monthly and the tension adjusted as necessary, but at least once every 3 months.



CAUTION

No service work should be performed on the drive system without first ensuring the fan and pump motors have been isolated, tagged and locked in the off position.

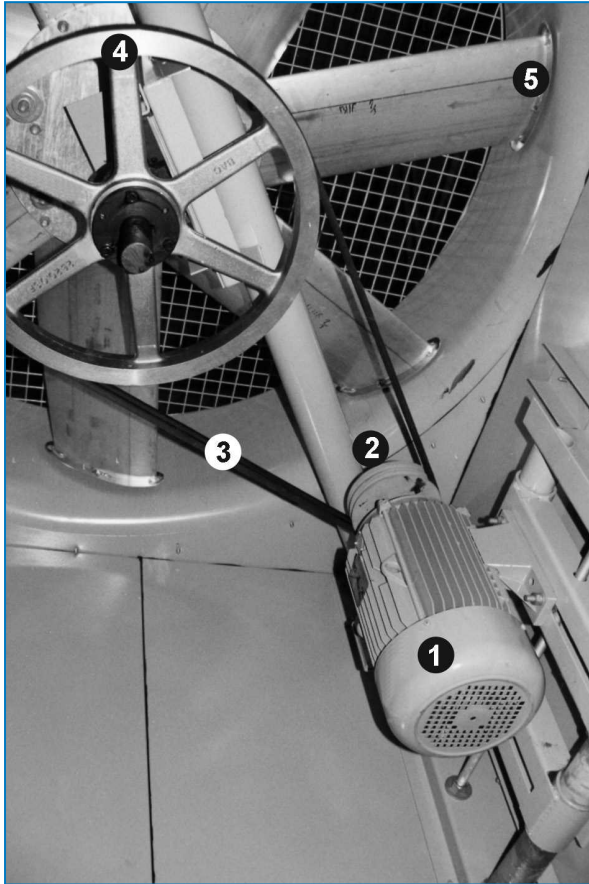

Drive system

1. Fan motor
2. Motor sheave
3. Belt
4. Cast aluminium fan sheave
5. Fans

Belt Tensioning

Check belt tension as follows:

1. Shut off fan(s).
2. Rotate the fan sheave half a turn to evenly distribute the tension in the belt before measuring.
3. Check belt tension by verifying both following conditions.
 - The deflection amounts 10 mm / m free belt length (see figure below).
 - The deflection force required is between the minimum and maximum values given in the table below.



CAUTION

Fan has to be blocked while replacing belts.

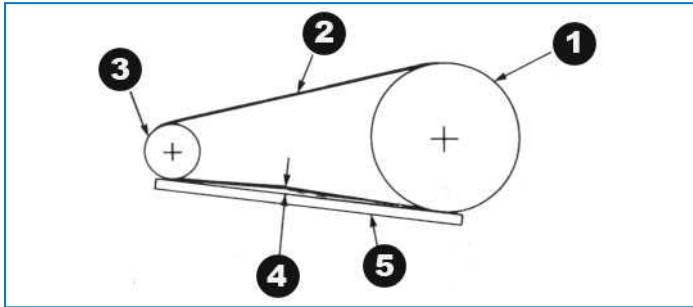

Fan belt check and adjustment

1. Fan sheave
2. Belt
3. Motor sheave
4. 10 mm/m deflection = proper belt tension
5. Straight edge



CAUTION

Over-tensioning of belts can lead to component damage.

Belt profile	Diameter (mm) motor sheave	Deflection force (kg)	
		Min.	Max.
B	100 through 118	1.5	2.0
	125 through 140	1.5	2.5
	150 through 170	2.0	2.5
	>180	2.5	3.0

Belt tension forces

New belts have to be re-tensioned after 24 hours operation.

If belt tensioning is required, please proceed as follows:

1. Loosen the lock nuts on the motor base adjusting screws.
2. Turn the motor base adjusting screws clockwise to tension the belt, or counter-clockwise to relieve belt tension. During adjustment of belt tension the drives should be rotated several times by hand to evenly distribute the tension throughout the belt.
3. When the belt is properly tensioned, re-tighten the locking nuts on the motor base adjusting screws.



There should be no "chirp" or "squeal" when the fan motor is started.

Drive Alignment

Proper drive alignment ensures maximum belt life. Alignment is checked for standard drives **after correct belt tensioning** by placing a straight-edge across both sheaves as shown in the figure below.

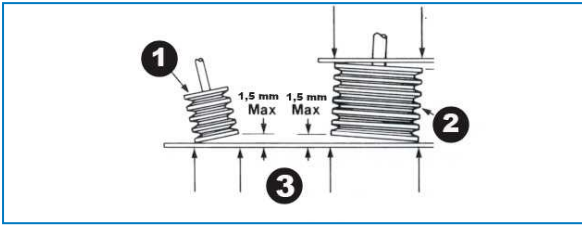

Sheave alignment standard drives

1. Motor sheave
2. Fan sheave
3. Points of contact

When the drives are properly aligned the straight edge will contact all four points as indicated. There should be no more than 1,5 mm deviation from four point contact. If realignment is necessary, loosen the motor sheave and align it with the fan sheave. Allow approximately 6 mm for draw-up as the bushing screw is re-tightened.

Locking Collar

The excentric locking collar of the bearing at the drive end ensures that the inner bearing race is secured to the fan shaft. Locking collars can be set using the following procedure. (See figure below)

1. Stop fan(s) and pump(s)
2. Loosen the set screw.
3. Using a drift pin centre-punch, tap the collar (in the hole provided) tangentially in the direction of rotation while holding the shaft.
4. Re-tighten the screw.
5. Close unit access door and start pump(s) and fan(s).

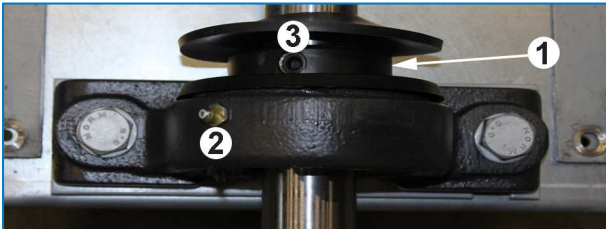

Locking collar assembly

1. Locking collar
2. Lubrication fitting
3. Set screw hole

ROTATION OF FAN(S) AND PUMP(S)

Fans must rotate without obstruction and both fans and pumps must rotate in the correct direction, which is indicated by arrows on the equipment. Do not start in opposite direction as indicated. Check proper functioning as follows:

1. Stop fan(s) and pump(s).
2. Turn the fan by hand to ensure rotation without obstruction. Remove obstruction, if present.
3. Start the pump(s) and check for the proper rotation as indicated by the arrow on the pump cover. If rotation is wrong, stop pump and correct electrical wiring.

4. Start the fan(s) and check for proper rotation as indicated by the arrow on the fan housing. If rotation is wrong stop fan(s) and contact BAC.



If the fan(s) and/or motor(s) are standing still, the shaft must rotate occasionally and a check by hand must be done to ensure they are not blocked during stand still. When blocked, the pump or fan has to be loosened before start up.

MOTOR VOLTAGE AND CURRENT

Check the voltage and the current of all three legs of the fan and pump motors. The current should not exceed the nameplate rating.

1. Insulation resistance test – minimum value should be 1 Mega Ohm (1.000.000 Ohms).
2. Thermistors, if fitted, should be checked for continuity with a multi-meter but never Megger-tested.
3. Ensure supply voltage and frequency correspond to the motor nameplate rating.
4. Ensure shaft turns freely.
5. Wire the motor in accordance with the wiring diagram as shown on the motor nameplate and/or in the motor terminal box.
6. Turn on unit and check amp draw does not exceed nameplate rating.



If motor is stored, it should be in a clean, dry place & have the shaft rotated occasionally. Storage areas should not be subject to vibration.



CAUTION

Rapid on-off cycling can cause the fan motor to overheat.

It is recommended that controls be set to allow a maximum of 6 on/off cycles per hour. When two speed motors are used, the motor starter should include a 15 seconds time delay when switching from high to low speed.

UNUSUAL NOISE AND VIBRATIONS

Unusual noise and/or vibration are the result of malfunctioning of mechanical components or operational problems (e.g. unwanted ice formation). If this occurs, a thorough inspection of the entire unit followed by immediate corrective action is needed. If required, consult your local BAC representative for assistance.

Inspections and corrective actions

GENERAL CONDITION OF THE EQUIPMENT

The inspection should focus on following areas:

- damage of corrosion protection
- signs of scale formation or corrosion
- accumulation of dirt and debris
- presence of biofilms

Smaller damages of the corrosion protection **MUST** be repaired as soon as possible to prevent the damage from getting bigger. For Baltibond® hybrid coating use kit (part number 160550). Larger damages should be reported to the local BAC representative.

If there is evidence of scale formation (more than 0,1 mm) or corrosion, water treatment regime must be checked and adjusted by the supplier.

Any dirt and debris need to be removed following the "Cleaning Procedures" on page 1 .

If there is evidence of biofilms the system, including piping should be drained, flushed and cleaned of slimes and other organic contamination. Refill system with water and apply biocide shock treatment. Check pH value and functionality of ongoing biocide treatment.

HEAT TRANSFER SECTION AND DRIFT ELIMINATORS

The inspection procedure is as follows:

1. Shut off fan(s) and pump(s).
2. Open or remove access doors and eliminators.
3. Inspect the coil surface for:
 - obstructions
 - damages
 - corrosion
 - fouling
4. After inspection, install eliminators and access doors and start pump(s) and fan(s).

Remove any obstructions from heat transfer section(s).

Any damages or corroded areas need to be repaired. Call your local BAC representative for assistance.

Minor fouling can usually be removed chemically or by temporary changes to the water treatment programme.

Contact your water treatment supplier for advice. Major fouling requires cleaning and flushing according to the "Cleaning Procedures" on page

Regular checking of the total aerobic bacteria count (TAB) and maintaining it within acceptable levels are the key to prevent fouling.

WATER DISTRIBUTION

The inspection procedure is as follows:

1. Shut off the fan(s), but leave the pump(s) running.
2. Check and adjust spray pressure, if required. (not applicable for coil models with standard pumps)
3. Check to see if the nozzles are spraying consistently and producing the spray pattern shown in the figure below.
4. Clean water distribution from dirt and debris. Ensure spray branches and nozzles are in place and clean. Replace damaged or missing nozzles.
5. Start fan(s) and pump(s).

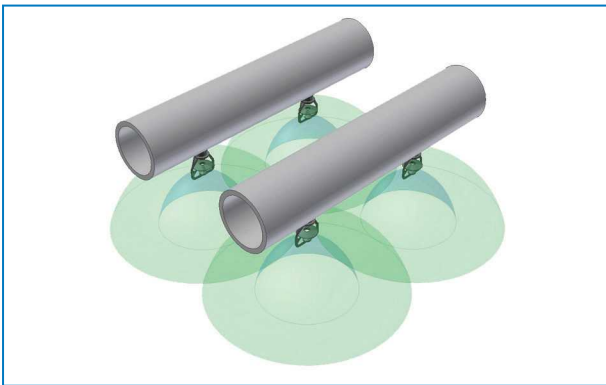

Nozzle spray distribution type for closed circuit cooling tower

COMBINED INLET SHIELDS

Combined inlet shields are installed at the air inlet side. These will prevent UV light from shining into the sump water and will reduce the suction of large airborne impurities and debris. In addition, they will prevent water from splashing out of the air intake side of the unit during fan cycling.



Inspect regularly and remove foreign objects that might impair air passage. Replace broken and missing parts when necessary. Failure to replace broken shields will result in water loss due to splash out. You can remove the combined inlet shields by simply unscrewing a single tapper on both ends of the air intake side. A supporting steel strip can be taken out. This allows simple removal of the combined inlet shields in small and easy to handle sections allowing full access to the sump section for maintenance. The shipping strap does not need to be restored afterwards.

1. Unscrew self-tappers and remove the horizontal metal shipping straps.



2. To remove the combined inlet shields, lift each section and pull at the lower end.



Remove combined inlet shields

3. Reinstall the cleaned combined inlet shields.
4. The supporting steel strip does not need to be reinstalled because it is only required for safe transport purposes.
5. Make sure the profile of the combined inlet shields keeps the water inside the unit. The correct position is with the horizontal part towards the outside of the unit and the sloping part facing downwards to the inside of the unit.

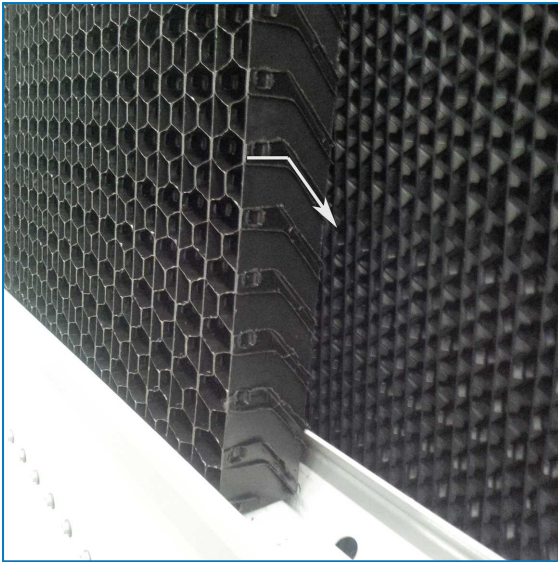

Orientation of the combined inlet shield

FAN SHAFT AND BUSHINGS

The exposed areas of the fan shaft and bushings are coated with a soft seal for added corrosion protection. It is recommended that the coating be inspected for continuity quarterly or at least every 6 months. Any signs of surface corrosion must be treated. This involves:

1. Removal of the protective coating with a suitable cleaning medium.
2. The removal of any surface corrosion with emery cloth.
3. The re-coating of the shaft and bushings with soft seal.

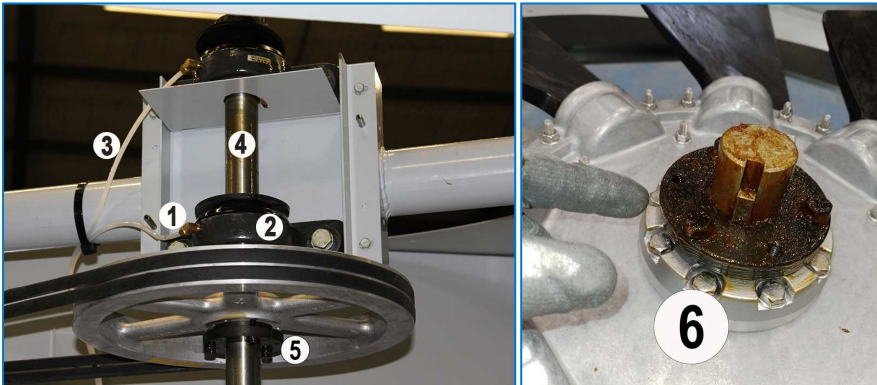

Location of fan shaft bearings and lube fittings

1. Lubrication fitting
2. Bearing
3. Extended lubrication line (option)
4. Fan shaft
5. Sheave bushing
6. Fan bushing

AXIAL FAN

Due to its size and speed, the axial fan has great potential for injury and destruction if damaged. Inspect closely, and as required, replace damaged or deteriorating fan blades. Inspection should include the fan, fan cylinder and fan guard, and these should be inspected for

- Fan blade tip clearance
- Pitch angle
- Bolt torque



- Excessive vibration
- Deterioration of fan assembly

Correct or adjust if necessary.



Before any disassembly, fan blades and hub should be match marked to ensure proper blade pitch angle when reassembled.



CAUTION

No service work should be performed on or near the fans, motors, and drives or inside the unit without first ensuring the fan and pump motors have been isolated, tagged and locked in the off position.

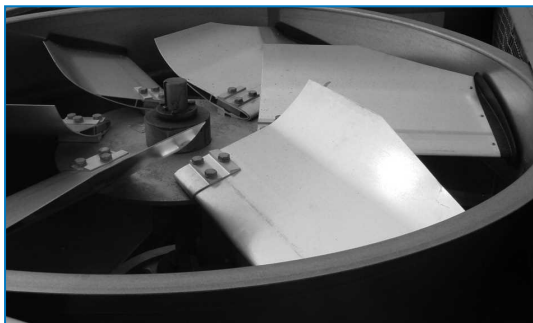

Axial fan

FAN MOTOR

The standard fan motor for this line of units is a TEFC (Totally Enclosed Fan Cooled) motor. The motor with frame size smaller or equal than 200L has permanently lubricated ball bearings and special moisture protection on the bearings, shaft and windings. The only servicing required during operation is to clean the outside surface of the motor at least quarterly to ensure proper motor cooling. After prolonged shutdowns, the motor insulation should be checked with a "Megger" insulation tester before restarting the motor.

Do not wash down the motor unless it is IP66 rated. On a quarterly basis check:

- electric connections
- motor protection devices
- amp draw
- motor bearings for noise/overheating
- motor holding bolts
- external surface of motor for corrosion

If the motor is equipped with space heaters, these must be activated when the motor is idle in order to prevent condensation inside the motor.



CAUTION

BAC fan motors are selected for optimal performance and maximum motor efficiency at the design conditions (during which airflow is required). At part load conditions or lower ambient temperatures the air density of the fan suction can change which might result in motor overload conditions if the fan speed is not slightly reduced.



CAUTION

BAC recommends a VFD switch which is programmed to limit the fan speed at the nominal current of the motor to avoid motor overload during these conditions. At lower ambient temperatures, the design cooling load can be met with reduced fan speed and lower absorbed fan power.

SPRAY WATER PUMP

The BAC pump contains a mechanical seal between pump housing and pump motor. This seal needs to be checked quarterly for proper operation and replaced if necessary.

The warranty coverage for pump seals is subject to certain limitations. Damages, primarily attributed to issues such as sticky seals, dry running, chemical attacks, and pollution by solids, fall outside the scope of our comprehensive warranty.

In the event of seal malfunction within the warranty period, a replacement seal will be provided. However it is essential to note that the warranty does not include the labour to replace the defective parts.

To prevent seal damage, pumps should be filled with water prior to starting and one must make sure the pump is loose by hand to avoid rupture which can occur due to sticky seal after a longer period of standstill.

Start-up

- Fill the cold water basin with fresh water to the overflow level via the make-up valve.
- Set the make-up valve float so the water shuts off at the overflow level.
- Start the spray pump.
- Open the valve in the unit bleed line.
- Start the fan motors.
- Adjust the bleed by closing or opening the bleed valve.
- Once the unit is operating, check the current and voltage of the fan motors with a heat load on the unit under warm ambient conditions. The current must not exceed the nameplate ratings.
- Check the operation of the optional vibration cutout switch.

After 24 hours of operation under thermal load, perform the following services:

- Check the unit for any unusual noise or vibrations.
- Check the operating water level in the cold water basin.
- Adjust make-up valve if necessary.
- Check the belt tension and readjust if necessary.



ELECTRIC WATER LEVEL CONTROL PACKAGE (OPTIONAL)

The electric water level control package (optional) maintains a constant water level in the cold water sump independent of cooling load changes and water supply pressure variations. Ensure every six months that all components (valve, float switches) are operational and clean.

During commissioning the unit should be filled manually till overflow level (push float ball under) to prevent air suction of the pump during first start-up.



CAUTION

When disassembling the float switch for cleaning, make sure to reassemble it in *exactly* the same position, otherwise it will not function correctly.

Lubrication

FAN SHAFT BEARINGS

The fan shaft is supported by two pillow block ball bearings (see figure below), each equipped with a lubrication fitting and a flinger/locking collar to keep out moisture.

Under normal operating conditions the bearings should be greased every 1000 operating hours or at least every three months. The bearings should be lubricated with one of the following water resistant inhibited greases, which are good for ambient temperature ranging from - 20°C to 120 °C.



Ball bearing

1. Bearing with locking collar
2. Lubrication fitting
3. Extended lubrication line

The bearings should be lubricated only with a hand grease gun. Do not use high-pressure grease guns, since they may rupture the bearing seals. When lubricating, purge the old grease from the bearing by gradually adding grease until a bead of new grease appears at the seal. In particular when extended lubrication lines are fitted ensure that all old grease is removed and that new grease is leaving the seal.

If bearings are replaced, grease must be added to the new bearings after installation. Make sure new bearings are fully greased (spare bearings may not be fully filled with grease).



Make sure greasing of the bearing is done gently, to avoid damage to the seal.



For grease products see table below.

MOTOR BEARINGS

Motor bearings are greased for bearing life.

External motors with frame size >200L (>30kW) have grease fittings

- grease intervals: twice a year unless otherwise shown on the nameplate of the motor
- grease products: see below

The bearings should be lubricated only with a hand grease gun. Do not use high pressure grease guns, since they may rupture the bearing seals. When lubricating, purge the old grease from the bearing by gradually adding grease until a bead of new grease appears at the seal.

GREASE PRODUCTS

Shell	Alvania grease RL3	-20°C to +120°C
Texaco	Multifak Premium 3	-30°C to +140°C
Klüber	Isoflex LDS Special A	-50°C to +120°C
Mobil	Mobilith SHC 100	-40°C to +175°C
Total Fina Elf	Multis 3	-20°C to +120°C

Grease products

ADJUSTABLE MOTOR BASE (BELT DRIVEN UNITS)

The motor base adjusting screw (see figure below) should be coated every six months using a good quality corrosion inhibiting grease, such as one of those recommended for lubricating the fan shaft bearings.

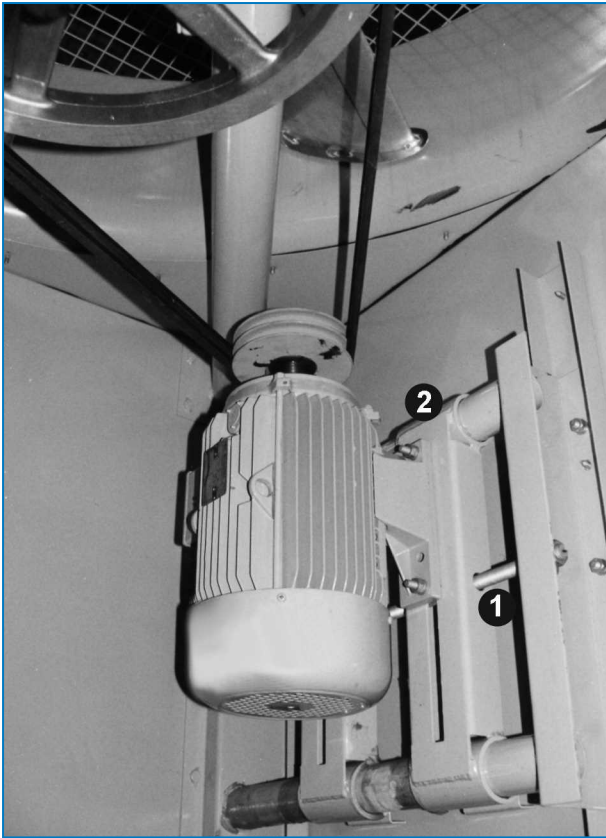

Adjustable motor base

1. Motor base adjusting screw
2. Adjustable motor base

Cleaning procedures

MECHANICAL CLEANING

Keeping your evaporative cooling equipment (and the associated system) clean will maintain its efficiency and help to prevent uncontrolled bacteriological growth. The recommended cleaning procedures are described below:

1. Disconnect fan and pump motor(s) and shut off make-up supply.
2. Remove combined inlet shields, eliminators and drain system. Do not remove sump strainer.
3. Clean debris from exterior and fan(s) with soft brush, if necessary use water and soap.
4. Clean interior with (soap) water and soft brush, if necessary use high pressure water jet.
5. Remove any debris from water distribution system and clean any nozzles if clogged. If necessary nozzle and grommet may be removed for cleaning.
6. Remove debris from heat transfer section (coil).
7. Flush with clean water and drain to remove accumulated dirt.
8. Remove, clean and replace sump strainer(s).
9. Clean debris from combined inlet shields and eliminators with water jet and install.
10. Remove debris from access doors and panels with soft brush and (soap) water.
11. Close drain and open make-up supply. Fill system up to overflow level with clean water.

DISINFECTION

Disinfection of your cooling system may be needed in case of high concentration of aerobic bacteria and/or Legionella. Disinfection is also recommended for evaporative cooling systems with known or suspected high bacteriological levels, prior to a cleaning procedure.

Some local or national guidance also recommends disinfection prior to initial start up, after a prolonged shut down, after routine cleaning operations or when significant alterations have been made to the cooling system. Disinfection must be carried out in accordance with a proper procedure and take into account the safety of the cleaning and disinfection staff.

Typically disinfection is achieved using a sodium hyper chloride solution to maintain a residual value of 5 - 15 mg/l of free chlorine and circulate this around the system for up to 6 hours. Higher chlorine levels for a shorter period are possible, but require a higher level of corrosion protection than galvanized steel only. Consult your BAC representative for further information.

Excessive levels of chlorine must be avoided as this quickly can lead to corrosion and damage to your system. Chlorinated water should be de-chlorinated before draining and after disinfection the system must be thoroughly flushed through with clean water.



A proper regularly monitored biocide programme reduces the need for cleaning and disinfection actions significantly.

7

FXVS

COMPREHENSIVE MAINTENANCE

About comprehensive maintenance

In order to ensure maximum efficiency and minimum downtime of your evaporative cooling system, it is recommended to establish and execute a programme of preventive maintenance.

Your local BAC representative will assist you in establishing and implementing such programme. The preventive maintenance programme must not only avoid that excessive downtime occurs under unforeseen and unwanted conditions, it also ensures that factory authorized replacement parts are used, which are designed to fit and for their purpose carry the full factory warranty. To order factory authorized parts, contact your local BAC representative. Make sure you include the unit serial number when ordering any parts.

To facilitate servicing of the equipment, it is suggested that the following parts be carried on hand:

- Make-up float ball (if applicable)
- Water make-up valve (if applicable)
- Fan shaft bearings
- Spray nozzles and grommets
- Spray distribution branch grommets
- Set of belts (if applicable)
- Baltiplus/Baltibond[®] repair (touch-up) kits

Insist on factory authorised parts to avoid loss of efficiency or an operational risk, which may occur when non authorised parts are used.

Prolonged outdoor stay

Should the unit(s) be stored outside for approximately one month (shelf life) or longer, or stored in severe climates, it is imperative that certain actions be performed by the installing contractor in order to maintain the unit in "as shipped" condition. These actions include but are not limited to:

- Rotate the fan(s) once per month, at least 10 revolutions.
- Rotate the motor shaft of all motors installed on the unit(s) once per month, at least 10 revolutions. This includes the pump motor.
- Add desiccant bags to control panel interiors to absorb moisture.
- Keep drains open on the cold water basins.
- Ensure unit(s) is stored on level ground surface and free from ambient vibration.
- Ensure hot water basins are covered.
- Remove and store fan belts and access door gaskets.
- Purge old bearing grease by new grease at start of storage period and repeat before start-up.
- Protect all black steel components with RUST VETO or equivalent corrosion protective material.



- Motors should be removed and stored inside whenever possible. When indoor storage is not possible the motors must be covered with a tarpaulin (do not use plastic). This cover should extend below the motor and be secured; however, it should not tightly wrap the motor. This will allow the captive air space to breathe, minimizing formation of condensation. Care must also be taken to protect the motor from flooding or from harmful chemical vapors. BAC motors are standard duty motors designed for storage at ambient temperatures of -25°C to 40°C. Prolonged periods of exposure below or above these specified conditions could degrade components of the motor and cause malfunction or premature failure.

For complete instructions, please contact your local BAC representative.



FXVS

FURTHER ASSISTANCE & INFORMATION

The service expert for BAC equipment

We offer tailored services and solution for BAC cooling towers and equipment.

- Original spare parts and fill -for an efficient, safe and year round reliable operation.
- Service solutions - preventive maintenance, repairs, refurbishments, cleaning and disinfection for reliable trouble-free operation.
- Upgrades and new technologies - save up energy and improve maintenance by upgrading your system.
- Water treatment solutions - equipment for controlling corrosion scaling and proliferation of bacteria.

For more details, contact your local BAC representative for further information and specific assistance at www.BACservice.eu

More information

REFERENCE LITERATURE

- Eurovent 9-5 (6) Recommended Code of Practice to keep your Cooling System efficient and safe. Eurovent/Cecomaf, 2002, 30p.
- Guide des Bonnes Pratiques, Legionella et Tours Aéroréfrigérantes. Ministères de l'Emploi et de la Solidarité, Ministère de l'Economie des Finances et de l'Industrie, Ministère de l'Environnement, Juin 2001, 54p.
- Voorkom Legionellose. Ministerie van de Vlaamse Gemeenschap. December 2002, 77p.
- Legionnaires' Disease. The Control of Legionella Bacteria in Water Systems. Health & Safety Commission. 2000, 62p.
- Hygienische Anforderungen an raumluftechnische Anlagen. VDI 6022.

INTERESTING WEBSITES

Baltimore Aircoil Company	www.BaltimoreAircoil.com
BAC Service website	www.BACservice.eu
Eurovent	www.eurovent-certification.com
European Working Group on Legionella Infections (EWGLI)	EWGLI
ASHRAE	www.ashrae.org
Uniclîma	www.uniclîma.fr
Association des Ingénieurs et techniciens en Climatique, Ventilation et Froid	www.aicvf.org
Health and Safety Executive	www.hse.gov.uk

ORIGINAL DOCUMENTATION



This manual is originally made in English. Translations are provided for your convenience. In the event of discrepancies, the English original text shall prevail over the translation.



A series of horizontal dotted lines for writing, spanning the width of the page.



A series of horizontal dotted lines spanning the width of the page, providing a template for writing or data entry.





A series of horizontal dotted lines for writing, spanning the width of the page.

COOLING TOWERS

CLOSED CIRCUIT COOLING TOWERS

ICE THERMAL STORAGE

EVAPORATIVE CONDENSERS

HYBRID PRODUCTS

PARTS, EQUIPMENTS & SERVICES

BLUE by nature
GREEN at heart



www.BaltimoreAircoil.com

Europe@BaltimoreAircoil.com

Please refer to our website for local contact details.

Industriepark - Zone A, B-2220 Heist-op-den-Berg, Belgium

© Baltimore Aircoil International nv